





Could package treatment plants be an alternative to onsite solutions





Jarmo Sallanko, Lab. Manager, Dr, Docent
 Department of process and environmental engineering
 Water resources and environmental engineering laboratory

UNIVERSITY of OULU
 OULUN YLIOPISTO 



CONTENT

- Background
- Types of package treatment plants
- When package plant
- Cooperation in waste water treatment
- Experiences of package plants

Jarmo Sallanko

UNIVERSITY of OULU
 OULUN YLIOPISTO 

Department of process and environmental engineering
Water resources and environmental engineering laboratory

- hydraulic testing hall
- water analytic laboratory
- geotechnology laboratory



- testing place for wastewater treatment systems



FINNISH SITUATION

Without connections to wastewater plants

- 300 000 households & 400 000 summer cottages

Must have good quality of wastewater handling

- New buildings from 2004 & old by 2014:

A) 90 % BOD₇ removal, 85 % P, 40 % N

B) 80 % BOD₇, 70 % P, 30 % N moderate requirements area

NOW mainly A, maybe change in law – mainly B (March ?)

Package treatment plants popular, questioning in North-karelia environmental center area (project: waste water treatment in scattered settlement area / Mavelpan Ltd, 2009, n = 38)

- Package treatment plants 45 %

UNIVERSITY of OULU
OULUN YLIOPISTO



TYPES OF SMALL WASTEWATER TREATMENT PLANTS



Bio – chemical
 Batch treatment
 Continuous process

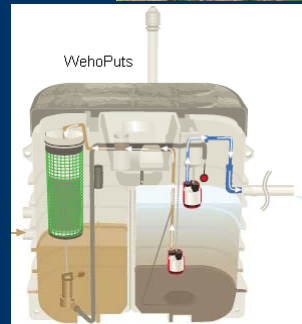
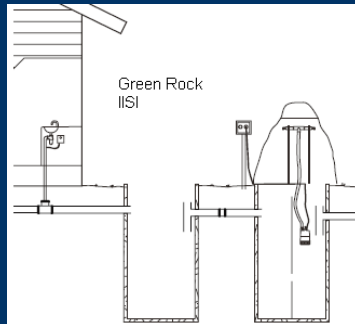

UNIVERSITY of OULU
 OULUN YLIOPISTO

How to do biology

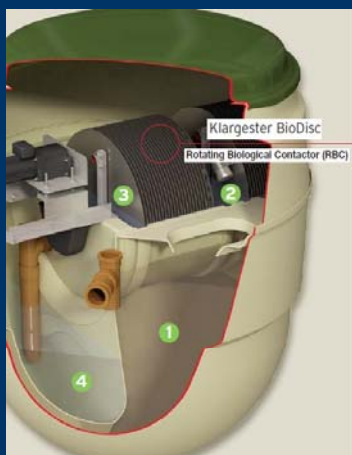

RBC = Rotating Biological Contactor

Jarmo Sallanko



Teoplast
 Biofilter



Activated sludge
 process

UNIVERSITY of OULU
 OULUN YLIOPISTO

WHEN PACKAGE TREATMENT SYSTEM ONE HOUSE - EXPENSES

-5 persons, including planning, permit, works & equipments & sewers in + out - treatment ,30 m
(www.hajavesihanke.sskoy.fi North Karelian Centre for Economic Development, Transport and the Environment / Maveplan Ltd)

	Investment, €
Soilinfiltation 40 m ²	3 000
Soilfiltration 20 m ²	4 500
Soilfiltration 40 m ²	5 500
Soilfiltration 40 m ² & powered P- removal (presedimentation in house)	6 000
Soilfiltration 40 m ² & <u>pumping</u> (soilfilter over earth ground)	7 000
Soilfiltration 40 m ² & powered P-removal (P-filtration mass in post filtration well)	7 000
Soilfiltration 40 m ² & powered P-removal (P-removal in separate P-sedimentation well)	8 000
<u>Cesspit</u> for black water & soilfilt. for grey ww	8 200
Biofilter, old septictanks	3 600
Biofilter	7 700
Bach treatment plant	8 500

Jarmo Sallanko

UNIVERSITY of OULU
OULUN YLIOPISTO



WHEN PACKAGE TREATMENT SYSTEM ONE HOUSE

Commual regulations
- Groundwater areas
- Shore areas

Small building place
Rocky building area
Wells etc.

Old septic tanks + biofilter
Need for pumping with
sandfilter
Need for more intensify P-
removal with soilfiltration



Jita Kemik

Jarmo Sallanko

UNIVERSITY of OULU
OULUN YLIOPISTO



WHEN PACKAGE TREATMENT SYSTEM MANY HOUSES

Population equivalent	Amount of waste water	Investment cost
PE	m ³ /d	€ VAT 0%
10	3	21 000
70	18	103 000
100	25	138 000
200	50	245 000
500	125	522 000
800	200	770 000
1 500	375	1 293 000
2 000	500	1 640 000

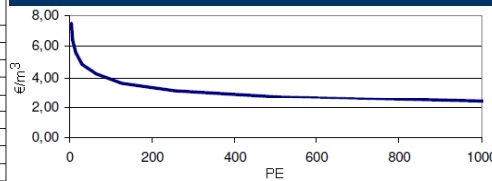

Investment costs of different size small waste water treatment plant

Total cost (investment & operating) of waste water treatment in different size of waste water plant

(Päijät-Hämeen haja-asutuksen vesihuollon kehittämissuunnitelma (Plan for water supply and sewerage development in Päijät -Häme), 2009, Rambol finland Oy / Päijät-Hämeen liitto).

Small scale cooperation

- investment & service contract more economical
- more reliable, more effective, more easy for owner



Jarmo Sallanko

UNIVERSITY of OULU
OULUN YLIOPISTO



EXPERIENCES OF SMALL WASTEWATER PLANTS

Tekniikan Maailma / Rakennusmaailma (Technology Word/Building word)
(2010 issues 5&8)



-testing place for wastewater treatment systems

- 8 small waste water plant
- Started 18.11. 2009

Jarmo Sallanko

UNIVERSITY of OULU
OULUN YLIOPISTO



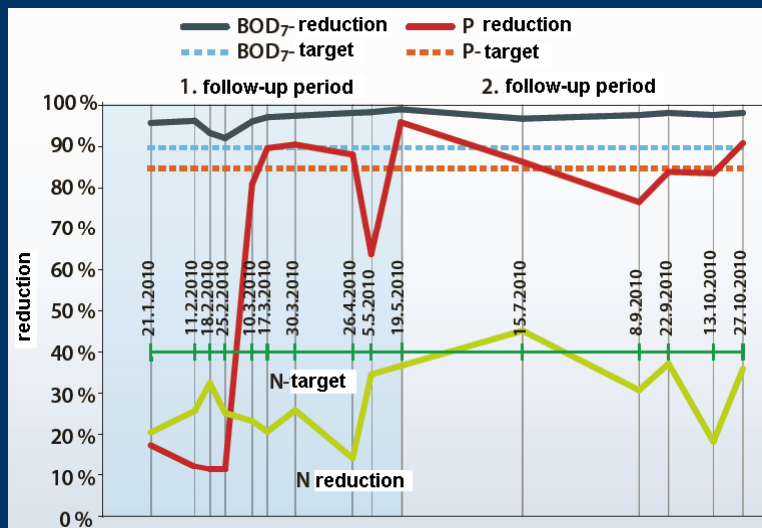

Example of results of follow-up study (TM Rakennusmaailma 2010) KWH Wehoputs

Jarmo Sallanko

UNIVERSITY of OULU
OULUN YLIOPISTO



Jarmo Sallanko

UNIVERSITY of OULU
OULUN YLIOPISTO





Thank You !



Jarmo Sallanko

UNIVERSITY of OULU
OULUN YLIOPISTO

